



Surge protection for safety lighting systems

White Paper



Contents

Surge protection for central power supply systems (central battery systems)

Lightning equipotential bonding for the circuits at the zone transition from the building to the ground

Lightning equipotential bonding at an E 30 line in an E 30 distribution board

Lightning equipotential bonding in a conventional distribution board

Surge protection for safety lighting systems

White Paper



The main functions of safety lighting systems are the designation and lighting of escape routes, lighting special risk work stations until work there has been finished in a safe manner and lighting to prevent panic.

The following looks at surge protection for central power supply systems (CPS), which are marketed as so-called central battery systems (CB).

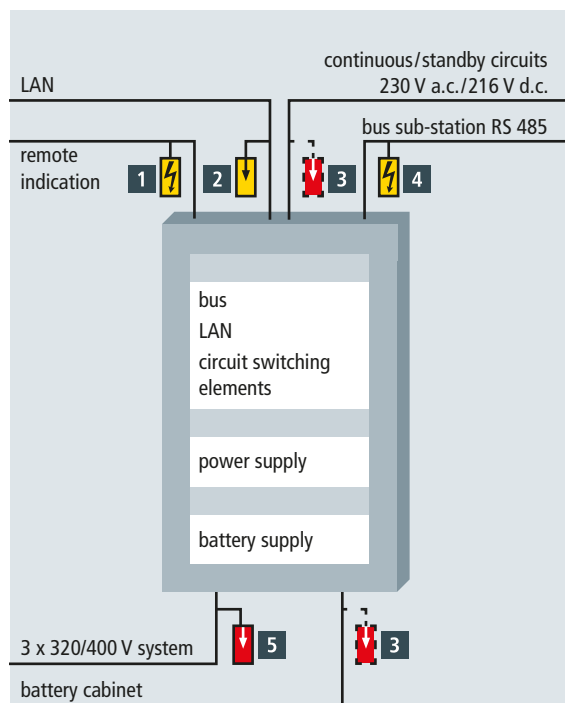

	Type	Info	Part No.
1	BXT ML4 BE 24 + BXT BAS	Earthing 6 mm ² Cu	920 324 + 920 300
2	DPA M CAT6 RJ45S 48	Earthing 1.5 mm ² Cu	929 100
3	DG SE DC 242 (2 pcs.) EB 1 2 1.5	Earthing 6 mm ² Cu	972 120 900 460
4	BXT ML2 BD HFS 5 + BXT BAS	Earthing 6 mm ² Cu	920 271 + 920 300
5	DG M TT 275		952 310

* Observe individual interfaces /system configurations

Figure 1 Central battery system, feeder cable, battery cabinet feeder cable, bus line, remote indication line, LAN line as well as continuous/standby circuit lines in LPZ 1 and in the same fire compartment

These systems feature the following interfaces:

- ➔ Power supply system
- ➔ Battery cabinet
- ➔ Circuit switching elements which, in combination with the system-specific electronic ballasts of the luminaires, ensure continuous/standby operation (individually assigned) and a switched permanent light in the circuit. These elements allow the required testing and monitoring of the individual lighting systems. Moreover, they incorporate the overcurrent protective devices required to protect the circuit
- ➔ Bus communication with the central battery system/sub-panels
- ➔ LAN
- ➔ Remote indication
- ➔ Freely programmable inputs and outputs

In general, a risk analysis must be performed to determine whether surge protective devices (SPDs) need to be installed for the interfaces. To protect the central battery system so that the risk is reduced to a minimum, surge protective devices are required for all the interfaces listed above (Figure 1). In Figures 1 to 4 the electronic symbols for SPDs with a solid line represent those which are, as a rule, obligatory for protecting the interfaces, whereas protective circuits with a dashed line are installed following a special risk analysis.

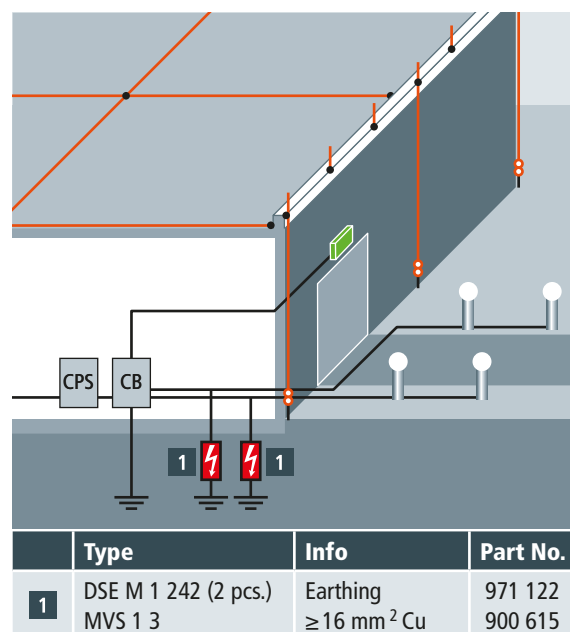

Figure 2 Lightning equipotential bonding for the circuits of the safety lighting system at the zone transition from the building to the grounding system

	Type	Info	Part No.
1	DSE M 1 242 (2 pcs.) MVS 1 3	Earthing ≥ 16 mm ² Cu	971 122 900 615

Surge protection for safety lighting systems

White Paper

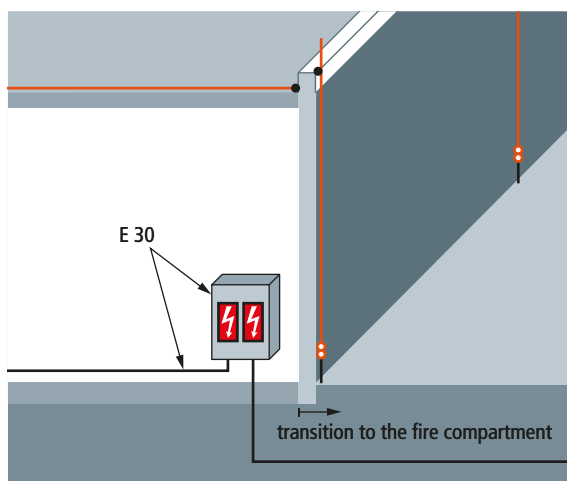

Figure 3 Lightning equipotential bonding at an E 30 line in an E 30 distribution board (inside of the outer wall)

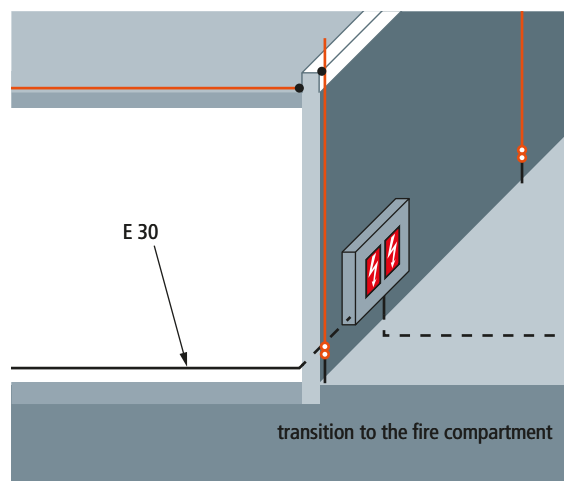

Figure 4 Lightning equipotential bonding in a conventional distribution board (outside of the outer wall)

While in **Figure 1** it is assumed that a coordinated type 1 lightning current arrester is installed in the power supply and information technology system of the building, a type 1 SPD is required for the outgoing circuits of the safety lighting system since lightning equipotential bonding is required (**Figure 2**). Since these circuits are supplied both during AC and DC operation, the type 1 arrester installed at the zone transition from LPZ 0_A to LPZ 1 (entry point to the building) must be suitable for this purpose. Technically, no standard spark-gap-based surge arresters, which have been developed and tested for operation in AC systems, can be used here. In such cases, DEHNsecure M 1 242 is the ideal protective device, designed for both AC and DC operation (max. backup fuse 10 A).

The functional integrity of the cable network is usually a must, not only in case of failure, but also if surge protective devices are used. This means that the surge protective device provided in the cable must be installed in an E 30 distribution board (**Figure 3**). To this end, the E 30 (integrity maintenance of 30 minutes) distribution board must be dimensioned in such a way that the maximum ambient temperature of the surge protective device cannot be exceeded. To ensure this, the data sheet of the surge protective device must be made available to the manufacturer of the E 30 distribution board. However, if the functional integrity cable is only led through the outside wall, a conventional distribution board, which must be selected according to IP criteria, is sufficient for the surge protective device (**Figure 4**).

DEHNsecure

DSE M 1 242 (971 122)

- Coordinated spark-gap-based lightning current arrester consisting of a base part and a plug-in protection module
- Spark gap technology particularly suited for use in d.c. circuits
- Directly coordinated with DEHNguard SE DC 242 (FM) surge protective devices



Figure without obligation

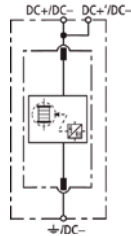

Basic circuit diagram DSE M 1 242

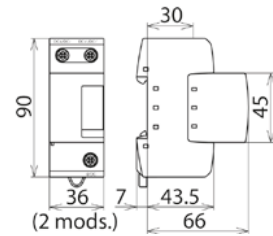

Dimension drawing DSE M 1 242

Coordinated and modular single-pole lightning current arrester for d.c. applications.

Type	DSE M 1 242
Part No.	971 122
SPD classification according to EN 61643-11 / IEC 61643-11	type 1 / class I
Max. continuous operating voltage (d.c.) (U_c)	242 V
Lightning impulse current (10/350 μ s) (I_{imp})	25 kA
Specific energy (W/R)	156.25 kJ/ohms
Voltage protection level (U_p)	≤ 2.5 kV
Directly coordinated with DEHNguard	DG S 385 (Part No. 952 074)
Response time (t_A)	≤ 100 ns
Short-circuit withstand capability for max. mains-side overcurrent protection d.c. (I_{SCCR})	25 kA
Max. mains-side overcurrent protection	250 A gL
Max. backup fuse (DC+/DC- -> DC+/DC-)	125 A gL
Operating temperature range (parallel connection) (T_{UP})	-40 °C ... +80 °C
Operating temperature range (series connection) (T_{US})	-40 °C ... +60 °C
Operating state / fault indication	green / red
Number of ports	1
Cross-sectional area (DC+/DC-, DC+/DC-, $\frac{1}{2}$ /DC-) (min.)	10 mm ² solid / flexible
Cross-sectional area (DC+/DC-, $\frac{1}{2}$ /DC-) (max.)	50 mm ² stranded / 35 mm ² flexible
Cross-sectional area (DC+/DC-) (max.)	35 mm ² stranded / 25 mm ² flexible
For mounting on	35 mm DIN rails acc. to EN 60715
Enclosure material	thermoplastic, red, UL 94 V-0
Place of installation	indoor installation
Degree of protection	IP 20
Capacity	2 module(s), DIN 43880
Extended technical data:	when used in safety lighting systems
- d.c. and a.c. operation	yes
- Max. continuous operating voltage (a.c.) (U_c)	255 V
Weight	258 g
Customs tariff number (Comb. Nomenclature EU)	85363090
GTIN	4013364144477
PU	1 pc(s)

DEHNguard

DG SE DC 242 (972 120)

- Universal single-pole surge arrester consisting of a base part and a plug-in protection module
- Powerful d.c. switching device DCD
- Can be used without additional backup fuse



Figure without obligation

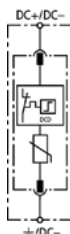

Basic circuit diagram DG SE DC 242

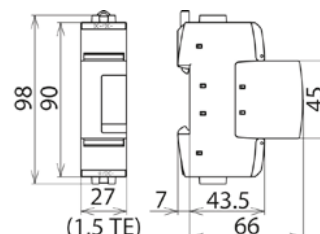

Dimension drawing DG SE DC 242

Modular single-pole surge arrester for d.c. applications.

Type	DG SE DC 242
Part No.	972 120
SPD according to EN 61643-11 / IEC 61643-11	type 2 / class II
Energy coordination with terminal equipment (≤ 10 m)	type 2 + type 3
Nominal voltage (d.c.) (U_N)	220 V
Max. continuous operating voltage (d.c.) (U_C)	242 V
Nominal discharge current (8/20 μ s) (I_n)	12.5 kA
Voltage protection level (U_P)	≤ 1.25 kV
Response time (t_A)	≤ 25 ns
Short-circuit withstand capability without backup fuse (d.c.) (I_{SCOR})	300 A
Short-circuit withstand capability for max. mains-side overcurrent protection (d.c.) (I_{SCOR})	25 kA
Max. mains-side overcurrent protection	35 A gG
Temporary overvoltage (TOV) d.c. (U_T) - Characteristic	320 V / 5 sec. – withstand
Temporary overvoltage (TOV) d.c., $2 \times U_C$ (U_T) - Characteristic	484 V / 120 min. – safe failure
Operating temperature range (T_U)	-40 °C ... +80 °C
Operating state / fault indication	green / red
Number of ports	1
Cross-sectional area (min.)	1.5 mm ² solid / flexible
Cross-sectional area (max.)	35 mm ² stranded / 25 mm ² flexible
For mounting on	35 mm DINs rails acc. to EN 60715
Enclosure material	thermoplastic, red, UL 94 V-0
Place of installation	indoor installation
Degree of protection	IP20
Capacity	1.5 module(s), DIN 43880
Extended technical data:	use for safety lighting systems
– d.c. and a.c. operation	yes
– Max. continuous operating voltage (a.c.) (U_C)	255 V
Weight	148 g
Customs tariff number (Comb. Nomenclature EU)	85363030
GTIN	4013364158528
PU	1 pc(s)

DEHNguard

DG M TT 275 (952 310)

- Prewired complete unit consisting of a base part and plug-in protection modules
- High discharge capacity due to heavy-duty zinc oxide varistors / spark gaps
- High reliability due to "Thermo Dynamic Control" SPD monitoring device



Figure without obligation

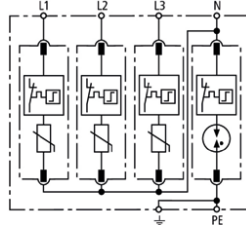

Basic circuit diagram DG M TT 275

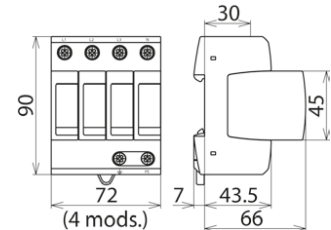

Dimension drawing DG M TT 275

Modular surge arrester for use in TT and TN-S systems (3+1 configuration).

Type	DG M TT 275
Part No.	952 310
SPD according to EN 61643-11 / IEC 61643-11	type 2 / class II
Energy coordination with terminal equipment (≤ 10 m)	type 2 + type 3
Nominal voltage (a.c.) (U_N)	230 / 400 V (50 / 60 Hz)
Max. continuous operating voltage (a.c.) [L-N] (U_C)	275 V (50 / 60 Hz)
Max. continuous operating voltage (a.c.) [N-PE] (U_C)	255 V (50 / 60 Hz)
Nominal discharge current (8/20 μ s) (I_n)	20 kA
Max. discharge current (8/20 μ s) (I_{max})	40 kA
Lightning impulse current (10/350 μ s) [N-PE] (I_{imp})	12 kA
Voltage protection level [L-N]/[N-PE] (U_P)	≤ 1.5 / ≤ 1.5 kV
Voltage protection level [L-N] / [N-PE] at 5 kA (U_P)	≤ 1 / ≤ 1.5 kV
Follow current extinguishing capability [N-PE] (I_f)	100 A _{rms}
Response time [L-N] (t_A)	≤ 25 ns
Response time [N-PE] (t_A)	≤ 100 ns
Max. mains-side overcurrent protection	125 A gG
Short-circuit withstand capability for max. mains-side overcurrent protection (I_{SCCR})	50 kA _{rms}
Temporary overvoltage (TOV) [L-N] (U_T) – Characteristic	335 V / 5 sec. – withstand
Temporary overvoltage (TOV) [L-N] (U_T) – Characteristic	440 V / 120 min. – safe failure
Temporary overvoltage (TOV) [N-PE] (U_T) – Characteristic	1200 V / 200 ms – withstand
Operating temperature range (T_U)	-40 °C ... +80 °C
Operating state / fault indication	green / red
Number of ports	1
Cross-sectional area (min.)	1.5 mm ² solid / flexible
Cross-sectional area (max.)	35 mm ² stranded / 25 mm ² flexible
For mounting on	35 mm DIN rails acc. to EN 60715
Enclosure material	thermoplastic, red, UL 94 V-0
Place of installation	indoor installation
Degree of protection	IP 20
Capacity	4 module(s), DIN 43880
Approvals	KEMA, VDE, UL
Extended technical data:	-----
Voltage protection level [L-PE] (U_P)	1.5 kV
Weight	405 g
Customs tariff number (Comb. Nomenclature EU)	85363030
GTIN	4013364108479
PU	1 pc(s)

Modular Wiring System

MVS 1 3 (900 615)

- Allows compact connection of arresters with each other and with other DIN rail mounted devices

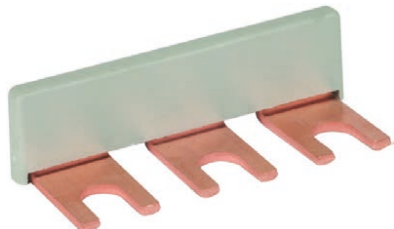
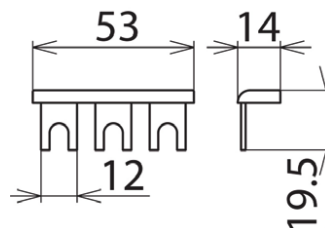

Figure without obligation



Type	MVS 1 3
Part No.	900 615
Type	single-phase
Number of contact studs	3
Max. installation length	3 module(s)
Nominal cross-section	16 mm ²
Weight	14 g
Customs tariff number (Comb. Nomenclature EU)	85389099
GTIN	4013364086562
PU	1 pc(s)

Earthing Clip

EB 1 2 1.5 (900 460)

- Allows compact connection of arresters with each other and with other DIN rail mounted devices



Figure without obligation

Type	EB 1 2 1.5
Part No.	900 460
Type	single-phase
Number of contact studs	2
Dimensions	34 x 60 x 28 mm
Material	copper and tin-plated brass
Terminal	up to 25 mm ²
Weight	37 g
Customs tariff number (Comb. Nomenclature EU)	85369095
GTIN	4013364244146
PU	1 pc(s)

BLITZDUCTOR XT

BXT ML2 BD HFS 5 (920 271)

- LifeCheck SPD monitoring function
- Minimal signal interference
- For installation in conformity with the lightning protection zone concept at the boundaries from $0_A -2$ and higher



Figure without obligation

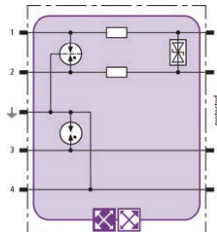

Basic circuit diagram BXT ML2 BD HFS

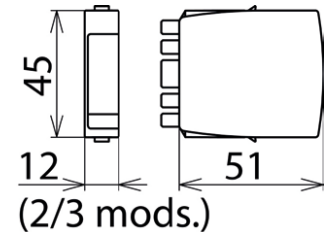

Dimension drawing BXT ML2 BD HFS

Space-saving combined lightning current and surge arrester module with LifeCheck feature for protecting one pair of unearthed high-frequency bus systems or video transmission systems, with direct or indirect shield earthing. If LifeCheck detects thermal or electrical overload, the arrester has to be replaced. This status is indicated contactlessly by the DEHNrecord LC / SCM / MCM reader.

Type	BXT ML2 BD HFS 5
Part No.	920 271
SPD monitoring system	LifeCheck
SPD class	TYPE 1 PE
Nominal voltage (U_N)	5 V
Max. continuous operating voltage (d.c.) (U_C)	6.0 V
Max. continuous operating voltage (a.c.) (U_C)	4.2 V
Nominal current at 45 °C (I_L)	1.0 A
D1 Total lightning impulse current (10/350 μ s) (I_{imp})	9 kA
D1 Lightning impulse current (10/350 μ s) per line (I_{imp})	2.5 kA
C2 Total nominal discharge current (8/20 μ s) (I_n)	20 kA
C2 Nominal discharge current (8/20 μ s) per line (I_n)	10 kA
Voltage protection level line-line for I_{imp} D1 (U_p)	≤ 25 V
Voltage protection level line-PG for I_{imp} D1 (U_p)	≤ 550 V
Voltage protection level line-line at 1 kV/ μ s C3 (U_p)	≤ 11 V
Voltage protection level line-PG at 1 kV/ μ s C3 (U_p)	≤ 550 V
Series resistance per line	1.0 ohm(s)
Cut-off frequency line-line (f_c)	100.0 MHz
Capacitance line-line (C)	≤ 25 pF
Capacitance line-PG (C)	≤ 25 pF
Operating temperature range (T_U)	-40 °C ... +80 °C
Degree of protection (with plugged-in protection module)	IP 20
Pluggable into	BXT BAS / BSP BAS 4 base part
Earthing via	BXT BAS / BSP BAS 4 base part
Enclosure material	polyamide PA 6.6
Colour	yellow
Test standards	IEC 61643-21 / EN 61643-21, UL 497B
Approvals	CSA, UL, EAC, ATEX, IECEx, CSA & USA Hazloc, SIL
SIL classification	up to SIL3 ^{*)}
ATEX approvals	DEKRA 11ATEX0089 X: II 3 G Ex nA IIC T4 Gc
IECEx approvals	DEK 11.0032X: Ex nA IIC T4 Gc
CSA & USA Hazloc approvals (1)	2516389: Class I Div. 2 GP A, B, C, D T4
CSA & USA Hazloc approvals (2)	2516389: Class I Zone 2, AEx nA IIC T4
Weight	22 g
Customs tariff number (Comb. Nomenclature EU)	85363010
GTIN	4013364117556
PU	1 pc(s)

^{*)} For more detailed information, please visit www.dehn-international.com.

BLITZDUCTOR XT

BXT ML4 BE 24 (920 324)

- LifeCheck SPD monitoring function
- Optimal protection of four single lines
- For installation in conformity with the lightning protection zone concept at the boundaries from $0_A - 2$ and higher



Figure without obligation

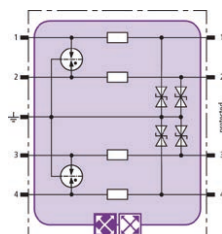

Basic circuit diagram BXT ML4 BE 24

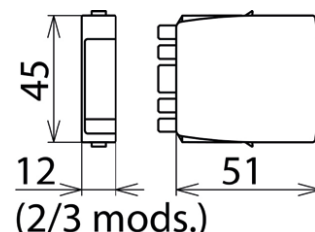

Dimension drawing BXT ML4 BE 24

Space-saving combined lightning current and surge arrester module with LifeCheck feature for protecting four single lines sharing a common reference potential as well as unbalanced interfaces. If LifeCheck detects thermal or electrical overload, the arrester has to be replaced. This status is indicated contactlessly by the DEHNrecord LC / SCM / MCM reader.

Type	BXT ML4 BE 24
Part No.	920 324
SPD monitoring system	LifeCheck
SPD class	TYPE 1 P_A
Nominal voltage (U_N)	24 V
Max. continuous operating voltage (d.c.) (U_c)	33 V
Max. continuous operating voltage (a.c.) (U_c)	23.3 V
Nominal current at 45 °C (I_L)	0.75 A
D1 Total lightning impulse current (10/350 μ s) (I_{imp})	10 kA
D1 Lightning impulse current (10/350 μ s) per line (I_{imp})	2.5 kA
C2 Total nominal discharge current (8/20 μ s) (I_n)	20 kA
C2 Nominal discharge current (8/20 μ s) per line (I_n)	10 kA
Voltage protection level line-line for I_{imp} D1 (U_p)	≤ 102 V
Voltage protection level line-PG for I_{imp} D1 (U_p)	≤ 66 V
Voltage protection level line-line at 1 kV/ μ s C3 (U_p)	≤ 90 V
Voltage protection level line-PG at 1 kV/ μ s C3 (U_p)	≤ 45 V
Series resistance per line	1.8 ohm(s)
Cut-off frequency line-PG (f_c)	6.8 MHz
Capacitance line-line (C)	≤ 0.5 nF
Capacitance line-PG (C)	≤ 1.0 nF
Operating temperature range (T_U)	-40 °C ... +80 °C
Degree of protection (with plugged-in protection module)	IP 20
Pluggable into	BXT BAS / BSP BAS 4 base part
Earthing via	BXT BAS / BSP BAS 4 base part
Enclosure material	polyamide PA 6.6
Colour	yellow
Test standards	IEC 61643-21 / EN 61643-21, UL 497B
Approvals	CSA, UL, EAC, ATEX, IECEx, CSA & USA Hazloc, SIL
SIL classification	up to SIL3 ^{*)}
ATEX approvals	DEKRA 11ATEX0089 X: II 3 G Ex nA IIC T4 Gc
IECEx approvals	DEK 11.0032X: Ex nA IIC T4 Gc
CSA & USA Hazloc approvals (1)	2516389: Class I Div. 2 GP A, B, C, D T4
CSA & USA Hazloc approvals (2)	2516389: Class I Zone 2, AEx nA IIC T4
Weight	38 g
Customs tariff number (Comb. Nomenclature EU)	85363010
GTIN	4013364109056
PU	1 pc(s)

^{*)} For more detailed information, please visit www.dehn-international.com.

BLITZDUCTOR XT

BXT BAS (920 300)

- Four-pole version for universal use with all types of BSP and BXT / BXTU protection modules
- No signal interruption if the protection module is removed
- Universal design without protection elements



Figure without obligation

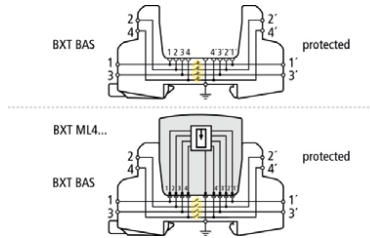

Basic circuit diagram with and without plugged-in module

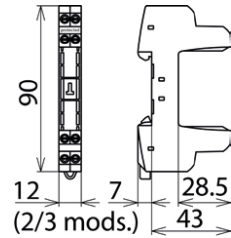

Dimension drawing BXT BAS

The BLITZDUCTOR XT base part is an extremely space-saving and universal four-pole feed-through terminal for the insertion of a protection module without signal disconnection if the protection module is removed. The snap-in mechanism at the supporting foot of the base part allows the protection module to be safely earthed via the DIN rail. Since no components of the protective circuit are situated in the base part, maintenance is only required for the protection modules.

Type Part No.	BXT BAS 920 300
Operating temperature range (T _U)	-40 °C ... +80 °C
Degree of protection	IP 20
For mounting on	35 mm DIN rails acc. to EN 60715
Connection (input / output)	screw / screw
Signal disconnection	no
Cross-sectional area, solid	0.08-4 mm ²
Cross-sectional area, flexible	0.08-2.5 mm ²
Tightening torque (terminals)	0.4 Nm
Earthing via	35 mm DIN rails acc. to EN 60715
Enclosure material	polyamide PA 6.6
Colour	yellow
ATEX approvals	DEKRA 11ATEX0089 X: II 3 G Ex nA IIC T4 Gc ^{*)}
IECEX approvals	DEK 11.0032X: Ex nA IIC T4 Gc ^{*)}
Approvals	CSA, UL, EAC, ATEX, IECEx ^{*)}
Weight	34 g
Customs tariff number (Comb. Nomenclature EU)	85369010
GTIN	4013364109179
PU	1 pc(s)

^{*)} only in connection with an approved protection module

DEHNpatch

DPA M CAT6 RJ45S 48 (929 100)

- Ideally suited for retrofitting, protection of all lines
- CAT 6A in the channel according to ANSI/TIA/EIA-568
- Power over Ethernet IEEE 802.3 compliant (up to PoE++ / 4PPoE)
- For installation in conformity with the lightning protection zone concept at the boundaries from $0_B -2$ and higher



Figure without obligation

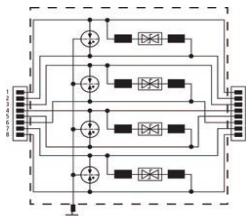

Basic circuit diagram DPA M CAT6 RJ45S 48

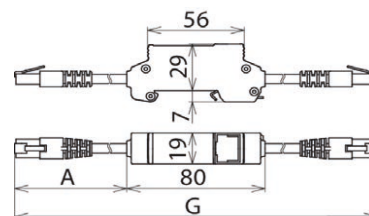

Dimension drawing DPA M CAT6 RJ45S 48

Universal arrester for Industrial Ethernet, Power over Ethernet (IEEE 802.3 compliant up to PoE++ / 4PPoE) and similar applications in structured cabling systems according to Cat. 6 and class E_A up to 500 MHz. Fully shielded type for DIN rail mounting.

Type	DPA M CAT6 RJ45S 48
Part No.	929 100
SPD class	TYPE 2 [P]
Nominal voltage (U _N)	48 V
Max. continuous operating voltage (d.c.) (U _c)	48 V
Max. continuous operating voltage (a.c.) (U _c)	34 V
Max. continuous operating voltage (d.c.) pair-pair (PoE) (U _c)	57 V
Nominal current (I _N)	1 A
D1 Lightning impulse current (10/350 μs) per line (I _{imp})	1 kA
C2 Nominal discharge current (8/20 μs) line-line (I _n)	150 A
C2 Nominal discharge current (8/20 μs) line-PG (I _n)	2.5 kA
C2 Nominal discharge current (8/20 μs) total (I _n)	10 kA
C2 Nominal discharge current (8/20 μs) pair-pair (PoE) (I _n)	150 A
Voltage protection level line-line for I _n C2 (U _p)	≤ 190 V
Voltage protection level line-PG for I _n C2 (U _p)	≤ 600 V
Voltage protection level line-line for I _n C2 (PoE) (U _p)	≤ 600 V
Voltage protection level line-line at 1 kV/μs C3 (U _p)	≤ 145 V
Voltage protection level line-PG at 1 kV/μs C3 (U _p)	≤ 500 V
Voltage protection level pair-pair at 1 kV/μs C3 (PoE) (U _p)	≤ 600 V
Cut-off frequency (f _c)	250 MHz
Insertion loss at 250 MHz	≤ 2 dB
Capacitance line-line (C)	≤ 165 pF
Capacitance line-PG (C)	≤ 255 pF
Operating temperature range (T _U)	-20 °C ... +60 °C
Degree of protection	IP 20
For mounting on	35 mm DIN rails acc. to EN 60715
Connection (input / output)	RJ45 connecting line / RJ45 connecting line
Pinning	1/2, 3/6, 4/5, 7/8
Connecting line	A = approx. 0.5 m, G = approx. 3 m
Connector	Stewart 39 series
Earthing via	35 mm DIN rail acc. to EN 60715
Enclosure material	zinc die-casting
Colour	bare surface
Test standards	IEC 61643-21 / EN 61643-21
Approvals	GHMT, EAC
Transmission class according to ISO/IEC 11801	Cat. 6
Transmission class according to EN 50173-1	Class E _A
Transmission class according to ANSI/TIA/EIA-568	cat. 6A in the channel
External accessories	fixing material
Weight	244 g
Customs tariff number (Comb. Nomenclature EU)	85363010
GTIN	4013364102170
PU	1 pc(s)

Surge Protection
Lightning Protection
Safety Equipment
DEHN protects.

DEHN SE
Hans-Dehn-Str. 1
Postfach 1640
92306 Neumarkt, Germany

Tel. +49 9181 906-0
Fax +49 9181 906-1100
info@dehn.de
www.dehn-international.com



www.dehn-international.com/partners

Type designations of products mentioned in this white paper which are at the same time registered trademarks are not especially marked. Hence the absence of TM or © markings does not indicate that the type designation is a free trade name. Nor can it be seen whether patents or utility models and other intellectual and industrial property rights exist. We reserve the right to introduce changes in performance, configuration and technology, dimensions, weights and materials in the course of technical progress. The figures are shown without obligation. Misprints, errors and modifications excepted. Reproduction in any form whatsoever is forbidden without our authorisation.

Photo "Emergency exit" by Megalesius (http://commons.wikimedia.org/wiki/File:Emergency_exit.jpg); Licence: CC BY-SA 3.0 (<http://creativecommons.org/licenses/by-sa/3.0/>)