



DEHN + SÖHNE

# Modular arc fault protection system DEHNarc



# Modular arc fault protection system DEHNarc

Siegfried Bombik, siegfried.bombik@technik.dehn.de  
Dr.-Ing. Arndt Ehrhardt, arndt.ehrhardt@technik.de  
Dr.-Ing. Michael Rock, michael.rock@technik.dehn.de  
Gerhard Rotter, gerhard.rotter@dehn.de  
DEHN + SÖHNE GmbH + Co. KG, Neumarkt/Opf.

## Abstract

Protection of persons against the effects of an arc fault, which cannot be completely excluded during live working, can be increased by using active protective equipment in addition to personal protective equipment. Such a protective equipment for use in low-voltage installations, the modular and portable DEHNarc protection system, which quickly extinguishes an arc by means of optical arc detection and a short-circuiter, will be presented. The detection with light sensors as well as the requirements and tests on tripping reliability and resistance to false tripping will be described. The short-circuiter with two short-circuiting cartridges and one disconnecting blade ensures the safe generation of a defined three-phase short-circuit in all types of systems. In this paper, the use and installation of the protection system in low-voltage switchgear installations, mainly with a high performance, will be explained. It could be demonstrated that, with this arc fault protection system, the thermal risks can be reduced far below the limits for second-degree burns, which is achieved by significantly reducing the arc fault duration.

## 1. Introduction

During live working in switchgear installations there is a low, but unpreventable residual risk of an arc fault to occur [1]. Such an arc fault often results in considerable damage to persons and installations.

Personal protective equipment (PPE), which is indispensable for live working, cannot actively influence an arc fault. Limitation of the arc energy, which can be particularly achieved by reducing the arc duration [2], considerably increases personal protection during live working if an arc fault occurs. The arc fault duration can be reduced by, for example, the proven use of safety fuse links [3].

Another possible method to achieve a short arc fault duration is to use a short-circuiter. An arc fault protection system with short-circuiter serves as additional protection as it considerably reduces the thermal and toxic effects of an arc fault. Even in case of high prospective short-circuit currents such a protection system provides comparably good protection in case of an arc fault. The DEHNarc protection system, a mostly portable protective equipment for the protection of persons during live working, will be presented as a technical solution.

## 2. Principle of the arc fault protection system with short-circuiter

To limit the arc fault duration, it is particularly efficient to quickly cause a short-circuit. The short-circuiter performs this task as the key element of the protection system. The principle of the protection system is based on the fast commutation of the arc fault current to the short-circuiter. This leads to the fast extinction of the arc fault before the overcurrent protective devices of the power supply system trip and is mostly independent of the intensity of the fault current. If the performance is adapted to the power supply system, the principle does not depend on the type and place of installation of the overcurrent protective device in the power supply system.

Depending on the type of installation, fault and fault location, the arc fault has an undefined impedance which also may stochastically change over the arc fault duration. These undefined impedance conditions lead to an almost unpredictable fault current. For this reason, the arc fault current considerably differs from the prospective short-circuit current; in the first approximation a current limitation of 50 % can be expected [4].

For this reason, the real effects of an arc fault might considerably differ from fault to fault. The short-circuit caused by the short-circuiter, however, represents a defined low-voltage state; almost the prospective short-circuit current known for the network node is flowing. The overcurrent protective devices of the power supply system, which are designed for these defined short-circuit conditions, disconnect the short-circuit. If fuses are used, the short-circuit current is disconnected within some milliseconds.

In order to efficiently complement the PPE to considerably improve personal protection during live working, numerous requirements are placed on the protection system based on a short-circuiter. When used during live working, the protection system must be largely mobile. The installation of the protection system must be simple and must not present additional risks. The protection system should not impede the actual live working process. The system must have a high tripping reliability in case of an arc fault and a high resistance to false tripping under normal conditions of use. The performance and operational reliability of the system largely have to be adapted to the conditions of use.

## 3. DEHNarc arc fault protection system

### 3.1 Components and installation

The DEHNarc protection system consists of several components. The schematic diagram in **Figure 1** shows the interconnection and the basic principle of operation of the components.

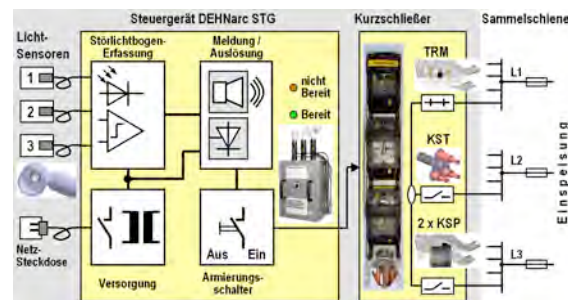

**Figure 1:** Schematic diagram of the DEHNarc arc fault protection system

The system consists of the basic components control unit (STG) and short-circuiter (KS). The control unit (STG) comprises the functional groups for arc fault detection, status indication, signalling, tripping of the short-circuiter and voltage supply. For the detection of an arc fault, the control unit features three optical sensors which are to be mounted in the sensor supports of the installation. These supports ensure a defined position and alignment of the three sensors during the installation of the protection system.

The short-circuiter consisting of two short-circuiter cartridges (KSP), a disconnecting blade (TRM) and a junction piece (KST) is situated in a fuse-disconnector which is directly mounted on the busbar of the switchgear installation. The control unit (STG) and the active elements of the short-circuiter (KS) are connected by means of control cables. The system is designed for a mostly portable installation.



The fuse-disconnector and the sensor supports are mounted in the low-voltage installation. If required, the fuse-disconnector can be used as a spare rail.

To commission the system during live working, the control unit (STG) is attached to the installation. The sensors are removed from the control unit and are inserted into the sensor supports. Fibre optic cables lead from the evaluation system in the control unit to the light sensors, which are positioned in the sensor supports of the switchgear installation in a defined way. The readiness for operation of the control unit (STG) and the state of the short-circuiter cartridges (KSP) are tested. The fuse-disconnector is equipped with the junction piece (KST), the disconnecting blade (TRM) and the short-circuiter cartridges (KSP) and is locked. The control unit (STG) is connected to the short-circuiter via control cables. Then, the complete device is commissioned. All commissioning activities can be considered as working in the vicinity of live parts.

### 3.2 Arc fault detection

The arc fault protection system works with purely optical arc fault detection with the highest spectral sensitivity in the visible range. Due to the mostly portable installation on live installations, no further elements were used for the detection of an arc fault. The evaluation system in the control unit evaluates the light falling on the sensors and detects an arc fault as soon as the threshold value of the illuminance exceeds a defined period of time or the illuminance changes with a certain steepness.

The optical detection of an arc fault places high demands on the sensors and the evaluation of the optical radiation with regard to the tripping reliability and resistance to false tripping. These important features were evaluated in numerous tests in a real low-voltage switchgear panel under consideration of the conditions of use of the system. The following was considered:

- Arcs with an extremely low light intensity (copper electrodes, 1 kA, spacing of 10 mm)
- Arcs with a high light intensity (aluminium electrodes, 25 kA, spacing of 100 mm)
- Extraneous light (additional lighting, indirect sunlight, light reflections, switching arcs)
- Sensors covered by parts of the installation or the worker

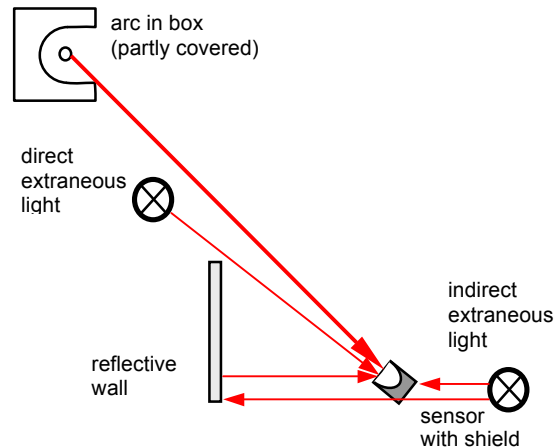
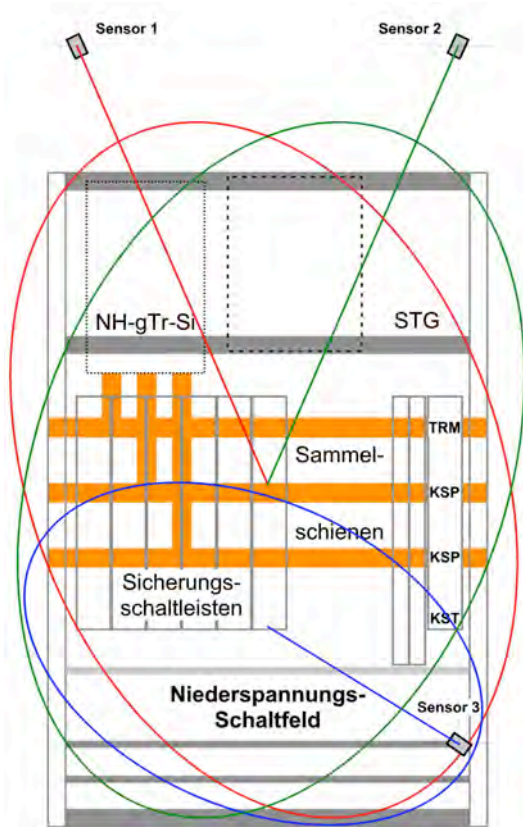

**Figure 2:** Testing the tripping reliability and resistance to false tripping in case of extraneous light

**Figure 2** shows the basic set-up for testing the tripping reliability in case of extraneous light sources. An arc with a low intensity was ignited in a box. The sensor alignment and the box partly cover the arc. The distance of the sensor was selected realistically. The sensor was exposed to direct, indirect or reflecting extraneous light depending on the additional lighting. The radiation spectrum, the light intensity, the light variation and the reflection intensity could be easily varied in this type of arrangement. In addition, the arc intensity and the cover were varied. The tests were specifically carried out in indoor installations. Intensive extraneous light sources such as photoflashes, floodlights, fluorescent lamps, xenon lamps and halogen lamps, which were switched on and off during the tests, did not trip the detection unit. To further improve this high tripping reliability and immunity to false tripping, the sensors were equipped with shields and reflectors. The extensive experiments revealed a high tripping reliability and immunity to false tripping [5].

Apart from these basic tests, additional tests were carried out in a real switchgear panel. The aim of these tests was to verify the results in a realistic arrangement under consideration of the special features during live working. Parts of the installation or workers may cover or shade the light sensors directing to the switchgear panel during live working. Extensive tests with low-current arcs (approximately 1 kA) were carried out in a real switchgear panel to determine the minimum required number of sensors as well as their optimal position and alignment.

For this purpose, arcs were ignited at certain points and a crouching or standing dummy was positioned at different positions in front of the switchgear panel. The aim was to optimise the number and the alignment of the sensors to ensure detection reliability. As a result, three optimally positioned light sensors are required in the switchgear panel area for safe arc fault detection. **Figures 3a and 3b** show their arrangement.

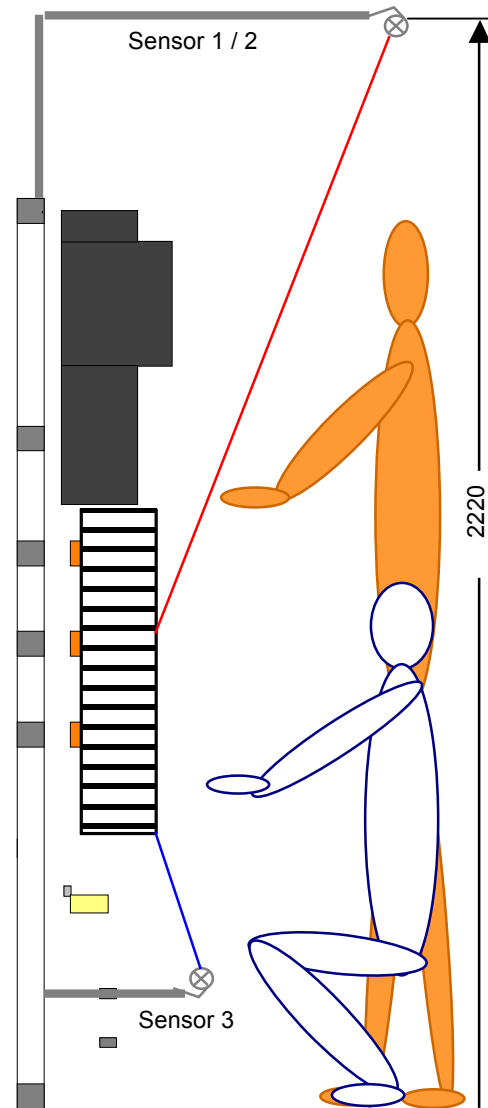

**Figure 3a:** Switchgear panel with the detection ranges of the sensors

To ensure reliable detection in practice, the sensors must be aligned so that they cannot be twisted or mixed up.

This is achieved by distinctive sensor supports and sensors.

The light sensors are connected to the control unit (STG) via fibre optic cables. An evaluation system, which activates the short-circuiter if an arc fault was detected, is integrated in the control unit.



**Figure 3b:** Switchgear panel with sensors and a crouching and a standing dummy

The detection time of the arc fault detection system depends on the intensity of the arc fault. In case of arcs in low-voltage installations with low current intensities in the range of the existence limit of approximately 1 kA, the detection time is typically about 20 ms. With an increasing current intensity the detection time is reduced to a minimum value of approximately 3.5 ms. This value is reached in case of current intensities of approximately 7 kA.

### 3.3 Short-circuiter

When using the DEHNarc protection system, a path is established in parallel to the arc fault with almost no delay after the short-circuiter has been activated by the evaluation system of the control unit (STG). This is achieved by the combination of antiparallel thyristors with mechanical short-circuiter cartridges (KSP). The short-circuiter therefore has no mechanical delay and does not need a considerable amount of auxiliary energy.

The short-circuiter cartridges (Figure 4) are disposable elements which can be simply replaced after a short-circuit [1], [2], [6].

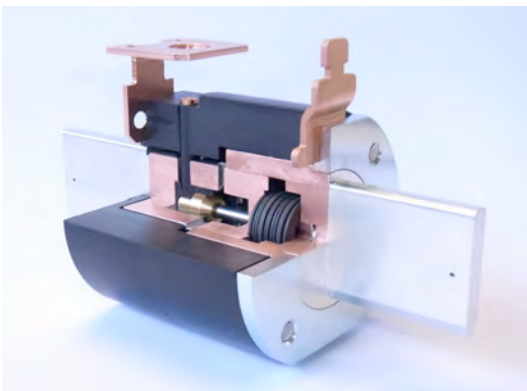

**Figure 4:** Cross-sectional view of a short-circuiter cartridge of size NH3

To generate a three-phase short-circuit, two short-circuiter cartridges (KSP) and a disconnecting blade (TRM) are inserted into an NH fuse-disconnector. This ensures current commutation and safe extinction of arc faults in all systems (TN, TT, IT) [1]. The fuse-disconnector features an integrated or additional lock, ensuring safe operation in case of high short-circuit current forces. The lockable fuse-disconnector is tested up to a prospective short-circuit current of 25 kA with a peak factor of 2.1. The junction piece connecting the outgoing lines of the fuse-disconnector also copes with short-circuit currents of this value and continuous currents according to the rated operating current of the fuse-disconnector.

The short-circuiter cartridges (KSP) and the modified disconnecting blade (TRM) are designed in such a way that, in case of an open fuse-disconnector, the same isolating distances can be achieved as in case of the actual use of the fuse-disconnector with fuse-links or disconnecting blades. If not activated, the short-circuiter cartridges (KSP) have an isolating distance with a nominal impulse withstand voltage of 6 kV and a power-frequency voltage strength (50 Hz) of 2 kV<sub>rms</sub>. The short-circuiter cartridges are

checked before inserting them into the fuse-disconnector. After the fuse-disconnector with the junction piece (KST), the short-circuiter cartridges (KSP) and the disconnecting blade (TRM) has been closed, it is locked. Only then the connectors can be used to connect the short-circuiter to the control unit (STG) via control cables. These control cables and connectors comply with CAT IV (600 V) [7].

## 4. Protective effect of the DEHNarc arc fault protection system

The high protective effect of the arc fault protection system is achieved by short arc fault times, which are

- typically 5 ms in case of high prospective short-circuit currents up to 25 kA<sub>rms</sub>,
- typically 8 ms in case of average prospective short-circuit currents of approximately 8 kA<sub>rms</sub> and
- typically 20 ms in case of low prospective short-circuit currents of 1 kA<sub>rms</sub>.

Arc faults were ignited several times at different locations in a switchgear panel with protection system. The arc was extinguished within some milliseconds. Arc burn-off and soiling were negligible.

To be able to assess the protective effect, in particular the thermal protective effect, with regard to danger to persons, a so-called box test was carried out with and without arc fault protection system using the same parameters. The applied prospective short-circuit current of 7.7 kA approximately corresponds to class 2 of material and protective clothing tests in accordance with [8] ( $I_{arc,class} = 7$  kA,  $E_{i0} = 423$  kJ/m<sup>2</sup>). In both tests the calorimeters were exposed to the immediate effects of the arc fault. Under real conditions of use, the temperature rise determined is reduced due to the mandatory PPE of the worker.

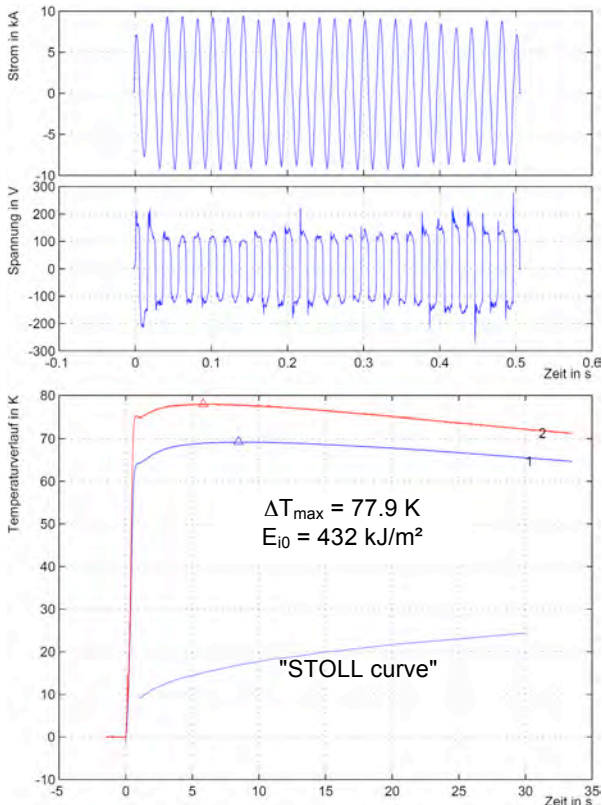

**Figure 5a:** Without DEHNarc: arc current of 6.2 kA for 500 ms

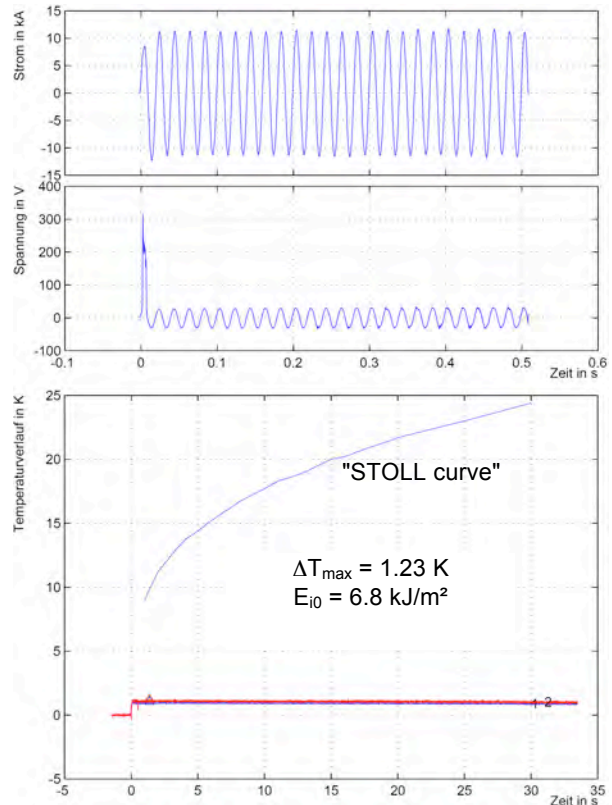

**Figure 5b:** With DEHNarc: short-circuit current of 7.7 kA for approximately 500 ms

*Note: Both measurements were carried out without PPE or fabric samples*

These box tests demonstrated (**Figure 5a**, **Figure 5b**), that, when using the arc fault protection system, the thermal risks, that is the temperature rise and the incident energy at a distance of 300 mm from the arc, remain considerably below the limit values for second-degree skin burns (STOLL curve). Moreover, the exposure duration of the radiation and sound effects is limited. The exposure duration and maximum value of the mechanical pressure is reduced.

## 5. Summary

The DEHNarc arc fault protection system consisting of an optical detection system, control unit, short-circuiter unit and cable connections is mainly designed for use in low-voltage main switchgear installations of high performance. If the protection system is connected directly downstream of the infeed transformer (**Figure 6**) with performances up to 630 kVA and transformer fuses (gTr) are installed, DEHNarc can handle prospective short-circuit currents up to 25 kA.

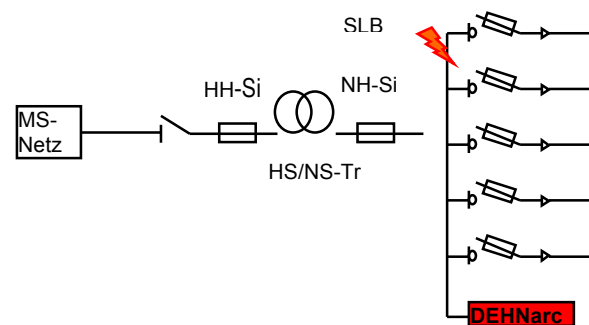

**Figure 6:** Single-phase circuit diagram with DEHNarc

The use of stationary, fixed components must be planned or these components must be retrofitted in the switchgear panel. A fuse-disconnector with a short-circuit strength of 25 kA tested in accordance with [9] must be available or made available. Space for the control unit and the mounting points for the light sensor supports must be provided.

Most of the components are portable and are tested and mounted immediately before commissioning. Functional tests of the light sensors, the control unit and the short-circuiter cartridges can be carried out using the DEHNarc TG test unit. When mounting the protection system in the switchgear panel, the control unit is attached to the structure of the switchgear panel, the light sensors are placed in the relevant supports, the short-circuiter cartridges and the disconnecting blade are inserted into the fuse-disconnector and the short-circuiter is connected to the control unit by means of control cables. As soon as the control unit is connected to mains voltage and is switched on, a self-test is performed and continuous arc fault detection is automatically started. The installation of the components is to be considered as working in the vicinity of live parts in areas where live parts must not be touched or bridged.

The arc fault protection system, which is a supplement to the PPE, significantly limits the thermal effects of an arc fault, in particular to protect persons. The portable design of the protection system allows operational use during live working [1].

## 6. Literature

- [1] Schau, H.; Ehrhardt, A.: Quenching arcing faults via a short-circuiter during live working up to 1000 V, Session S3, 9<sup>th</sup> International Conference on Live Maintenance (ICOLIM), Torun, Poland, 4<sup>th</sup> to 6<sup>th</sup> June 2008, conference transcript, pp. 72 – 84
- [2] Schau, H.; Ehrhardt, A.: Einsatz von Kurzschließern zum Schutz von Personen beim AuS [Use of short-circuiters for protecting persons during live working], 7. Fachtagung "Arbeiten unter Spannung (AuS)", Technical University of Dresden, 19<sup>th</sup> to 20<sup>th</sup> September 2007, ETG technical report, volume 106, 2007, pp. 83 – 90
- [3] Schüppenbauer, A.: Personenschutz durch Sicherungen bei Arbeiten unter Spannung; Sicheres Arbeiten mit Arbeitsschutz-Sicherungen [Personal protection during live working by means of fuses; safe working with safety fuse inserts], 3. Sicherheitstag NH/HH-Recycling, Würzburg 2010, conference transcript, pp. 165 – 173; pp. 191 – 199, ISBN: 978-3-931954-18-5
- [4] Schau, H.: Einschätzung der Personengefährdung durch Störlichtbögen in Niederspannungsnetzen [Assessment of the risk to persons posed by arc faults in low-voltage systems], 3. Sicherheitstag NH/HH-Recycling, Würzburg 2010, conference transcript, pp. 139 – 152, ISBN: 978-3-931954-18-5
- [5] Ehrhardt, A.; Schau, H.: Proving of the tripping safety of a novel device for arc flash protection, Session 6.5, 54. Internationales Wissenschaftliches Kolloquium (IWK), Ilmenau University of Technology, 07<sup>th</sup> – 10<sup>th</sup> September 2009, 8 pages
- [6] Schau, H.; Halinka, A.; Winkler, W.: Elektrische Schutzeinrichtungen in Industrienetzen und -anlagen, Grundlagen und Anwendungen [Electrical protective equipment in industrial networks and systems], Hüthig & Pflaum Verlag, München/Heidelberg, 2008, ISBN: 978-3-8101-0255-3
- [7] Safety requirements for electrical equipment for measurement, control and laboratory use - Part 031: Safety requirements for hand-held probe assemblies for electrical measurement and test, June 2008
- [8] IEC 61482-1-2: Live working – Protective clothing against the thermal hazards of an electric arc – Part 1-2: Test methods – Method 2: Determination of arc protection class of material and clothing by using a constrained and directed arc (box text), January 2007
- [9] IEC 60947-3: Low-voltage switchgear and controlgear - Part 3: Switches, disconnectors, switch-disconnectors and fuse-combination units, August 2008





**DEHN + SÖHNE**

**Surge protection  
Lightning protection / Earthing  
Safety equipment**

DEHN + SÖHNE  
GmbH + Co.KG.  
Hans-Dehn-Str. 1  
Postfach 1640  
92306 Neumarkt  
Germany

Tel. +49 9181 906-0  
Fax +49 9181 906-100  
[www.dehn.de](http://www.dehn.de)  
[info@dehn.de](mailto:info@dehn.de)

© COPYRIGHT 2011 DEHN + SÖHNE

Foto: J.Vogler

