

PSO M8 W45 PHE (766 941)



Figure without obligation

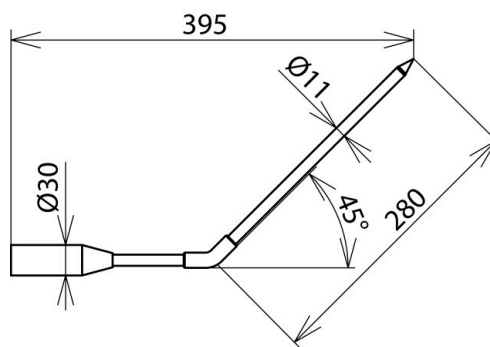

Figure without obligation

Type	PSO M8 W45 PHE
Part No.	766 941
Nominal voltage (U _N)	1 ... 24 kV
Total length (l _G)	395 mm
Length (l ₁)	280 mm
Diameter	11 mm
For use at	*
Suitable for	PHE4, PHE III, PHE
Weight	150 g
Customs tariff number (Comb. Nomenclature EU)	90309000
GTIN	4013364080478
PU	1 pc(s)

We reserve the right to introduce changes in performance, configuration and technology, dimensions, weights and materials in the course of technical progress. The figures are shown without obligation.

Test probes for other special switchgear installations are available on request.